

**GENERAL FEATURES**

- Environmentally friendly
- Can be used at vertical or horizontal orientation
- High Reliability and Good Quality
- High gas recombination efficiency
- High Power Density
- Maintenance-Free Operation

**APPLICATIONS**

- UPS & EPS
- Emergency lighting Systems
- Medical Equipment
- Cable TV Systems
- Alarm Systems
- Electric Test Equipment
- Security Systems



**DIMENSIONS & WEIGHT**

Length(mm)	331±1
Width(mm)	174±1
Height(mm)	214±1
Total Height(mm)	219±1
Weight(kg)	28.7±3%

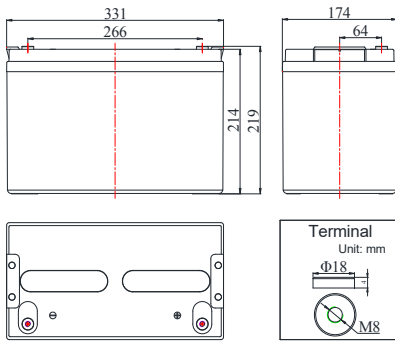

**COMPLIED STANDARDS**

IEC 60896-21/22	JIS C8704
YD/T799	BS6290 part4
GB/T 19638	UL 1989

**TECHNICAL SPECIFICATIONS**



<b>Nominal Voltage</b>		<b>12V(6 cells per unit)</b>
<b>Design Floating Life @25°C</b>		<b>10 Years</b>
<b>Nominal Capacity @25°C(10 hour rate@10.00A,10.80V)</b>		<b>100Ah</b>
<b>Capacity @25°C</b>	20 hour rate (5.50A,10.2V)	110.0Ah
	5 hour rate (17.6A,10.5V)	88.0Ah
	1 hour rate (63.8A,9.6V)	63.8Ah
<b>Internal Resistance</b>	<b>Full Charged Battery@25°C</b>	≤5.3mΩ
<b>Ambient Temperature</b>	<b>Discharge</b>	-20°C ~50°C
	<b>Charge</b>	-20°C ~50°C
	<b>Storage</b>	-20°C ~50°C
<b>Max.Discharge Current@25°C</b>		<b>1000A(5s)</b>
<b>Capacity affected by Temperature (10 hr Capacity )</b>	40°C	102%
	25°C	100%
	0°C	85%
	-15°C	65%
<b>Self-Discharge@25°C per Month</b>		<b>3%</b>
<b>Charge (Constant Voltage) @25°C</b>	<b>Standby Use</b>	<b>Initial Charging Current Less than 25A Voltage 13.6-13.8V</b>
	<b>Cycle Use</b>	<b>Initial Charging Current Less than 25A Voltage 14.4-14.9V</b>

**BATTERY DISCHARGE TABLE**

**Discharge Constant Current per Cell (Amperes at 25 C)**

F.V/Time	15min	30min	45min	1h	2h	3h	5h	6h	8h	10h	20h
1.60V	180.5	106.3	80.5	63.8	37.5	27.6	18.6	16.2	12.7	10.5	5.55
1.67V	170.5	100.7	77.4	61.9	36.3	26.7	18.3	15.9	12.6	10.3	5.50
1.70V	160.1	97.8	74.6	59.5	35.3	26.0	17.9	15.6	12.4	10.2	5.42
1.75V	150.0	93.5	71.3	57.1	34.4	25.4	17.6	15.3	12.2	10.1	5.35
1.80V	140.7	90.1	68.7	55.1	33.1	24.6	17.2	15.0	12.0	10.0	5.30

**Discharge Constant Power per Cell (Watts at 25 C)**

F.V/Time	15min	30min	45min	1h	2h	3h	5h	6h	8h	10h	20h
1.60V	345.1	211.1	152.9	122.4	71.1	52.7	35.9	31.3	24.8	20.5	10.96
1.67V	330.2	197.9	147.7	119.1	69.2	51.3	35.3	30.8	24.6	20.3	10.88
1.70V	307.7	193.6	143.0	115.0	67.6	50.1	34.8	30.4	24.3	20.1	10.74
1.75V	288.7	184.3	137.3	110.8	66.0	49.1	34.3	29.9	24.0	19.9	10.65
1.80V	271.0	176.8	132.7	107.2	63.8	47.7	33.6	29.4	23.7	19.8	10.56

Note The above data are average values, and can be obtained within 3 charge/discharge cycles. These are not minimum values. Cell and battery designs/specifications are subject to modification without notice. Contact **DBS srl** for the latest information.

## PERFORMANCE CHARACTERISTICS

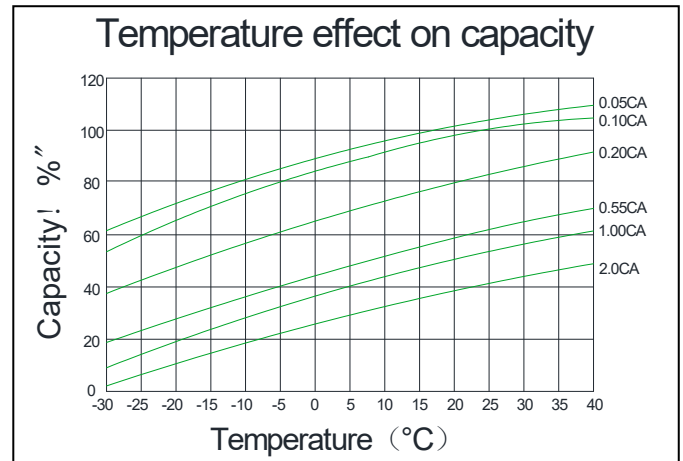
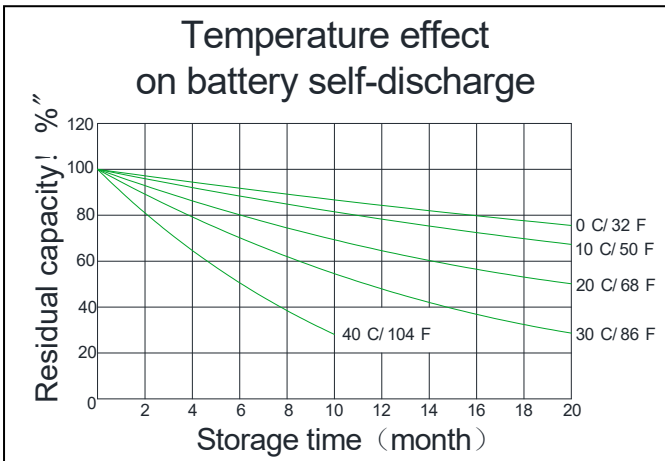
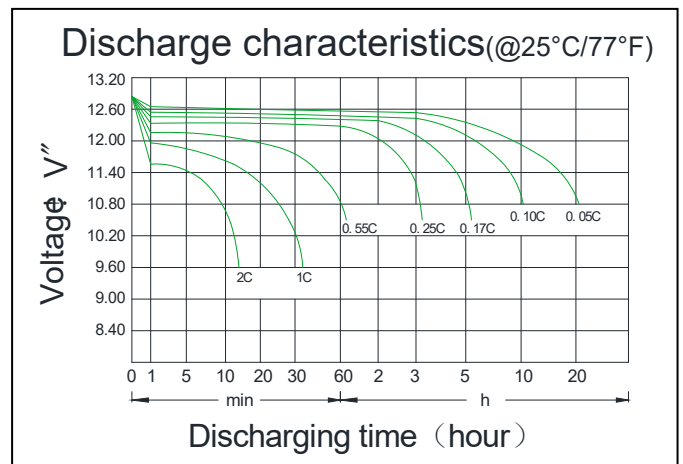
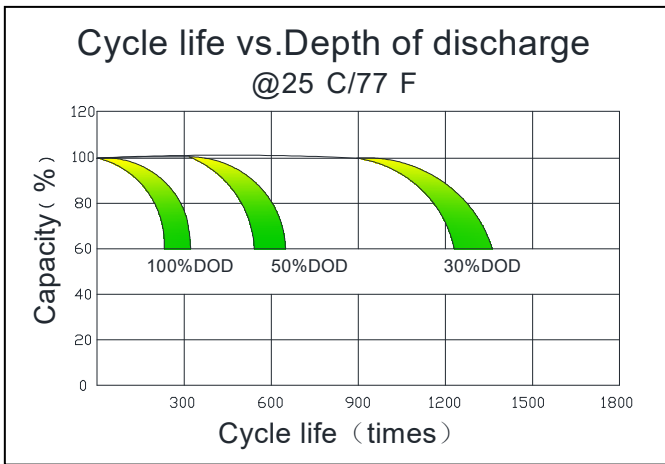
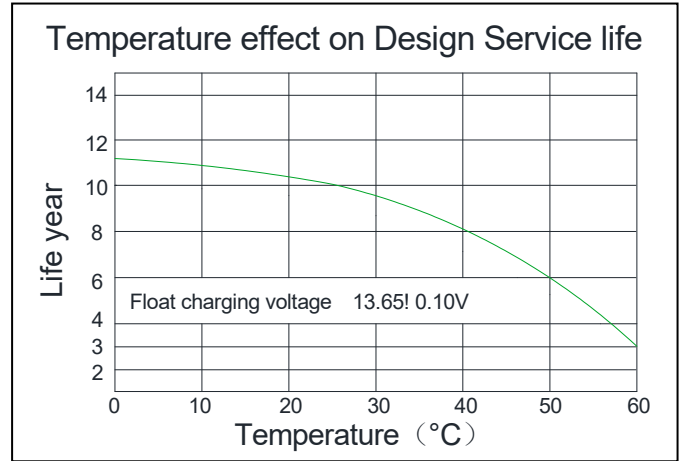
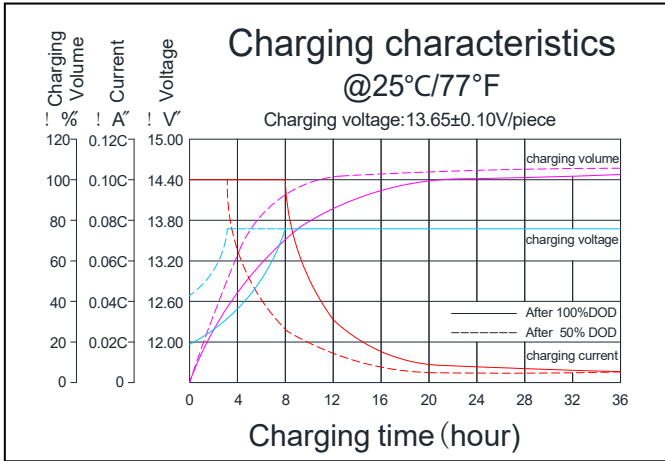

## BATTERY CONSTRUCTION

Component	Positive plate	Negative plate	Container & Cover	Safety valve	Terminal	Separator	Electrolyte	Pillar seal
Features	Thick high Sn low Ca grid with special paste	Balanced Pb-Ca grid for improved recombination efficiency	ABS (UL94-V0 optional)	Flame Si-Rubbeand aging resistancer	Female Copper Insert M8(torque:7~9N.m)	Advanced AGM separator for high pressure cell design	Dilute high purity sulphuric acid	Two layers epoxy resin seal