

GENERAL FEATURES

- Environmentally friendly
- Can be used at vertical or horizontal orientation
- High Reliability and Good Quality
- High gas recombination efficiency
- High Power Density
- Maintenance-Free Operation

APPLICATIONS

- UPS & EPS
- Emergency lighting Systems
- Medical Equipment
- Cable TV Systems
- Alarm Systems
- Electric Test Equipment
- Security Systems

DIMENSIONS & WEIGHT

Length(mm)	151±1
Width(mm)	34±1
Height (mm)	95±1
Total Height(mm)	101±1
Weight(kg)	1.08±3%

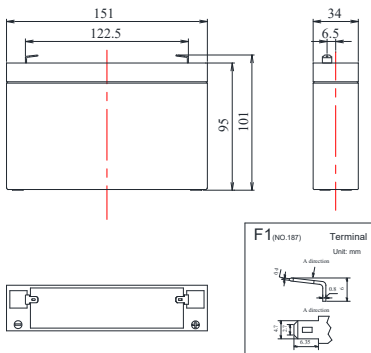

COMPLIED STANDARDS

IEC 60896-21/22	JIS C8704
YD/T799	BS6290 part4
GB/T 19639	UL 1989

TECHNICAL SPECIFICATIONS



Nominal Voltage		6V(3 cells per unit)
Design Floating Life @25°C		5 Years
Nominal Capacity @25°C (20 hour rate@0.350A,5.25V)		7.00Ah
Capacity @25°C	10 hour rate (0.66A,5.40V)	6.60Ah
	5 hour rate (1.23A,5.25V)	6.15Ah
	1 hour rate (4.57A,4.80V)	4.57Ah
Internal Resistance	Full Charged Battery@25°C	≤18.0mΩ
Ambient Temperature	Discharge	-20°C ~50°C
	Charge	-20°C ~50°C
	Storage	-20°C ~50°C
Max.Discharge Current@25°C		105.0A(5s)
Capacity affected by Temperature (10 hr Capacity)	40°C	102%
	25°C	100%
	0°C	85%
	-15°C	65%
Self - Dis charge @25°C		3%
Charge (Constant Voltage) @25°C	Standby Use	Initial Charging Current Less than 2.10A Voltage 6.8-6.9V
	Cycle Use	Initial Charging Current Less than 2.10A Voltage 7.2-7.45V

BATTERY DISCHARGE TABLE

Discharge Constant Current per Cell (Amperes at 25°C)

F.V/Time	5min	10min	15min	30min	45min	1h	2h	3h	5h	8h	10h	20h
1.60V	27.94	18.32	13.45	7.98	5.82	4.57	2.89	1.98	1.29	0.89	0.70	0.370
1.67V	26.62	17.56	13.16	7.85	5.73	4.42	2.84	1.94	1.27	0.87	0.69	0.363
1.70V	25.50	16.60	12.98	7.75	5.66	4.28	2.78	1.91	1.24	0.85	0.68	0.357
1.75V	24.30	15.83	12.29	7.49	5.51	4.15	2.73	1.87	1.23	0.84	0.67	0.350
1.80V	22.44	14.75	11.47	7.19	5.33	4.03	2.63	1.80	1.18	0.82	0.66	0.346

Discharge Constant Power per Cell (Watts at 25°C)

F.V/Time	5min	10min	15min	30min	45min	1h	2h	3h	5h	8h	10h	20h
1.60V	52.03	35.16	26.00	15.53	11.36	8.99	5.67	3.91	2.56	1.77	1.40	0.738
1.67V	49.86	33.74	25.50	15.31	11.21	8.68	5.57	3.83	2.51	1.74	1.39	0.727
1.70V	47.81	31.91	25.21	15.14	11.10	8.37	5.47	3.76	2.47	1.72	1.38	0.718
1.75V	45.80	30.47	23.92	14.68	10.83	8.06	5.37	3.69	2.42	1.70	1.36	0.703
1.80V	42.70	28.49	22.36	14.14	10.50	7.75	5.15	3.55	2.33	1.66	1.34	0.700

PERFORMANCE CHARACTERISTICS

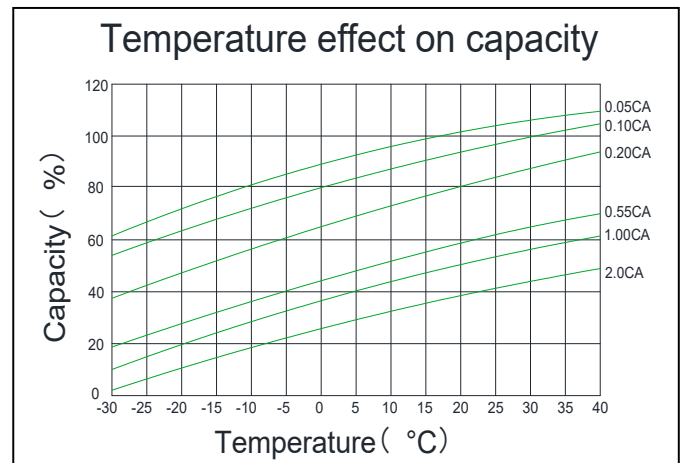
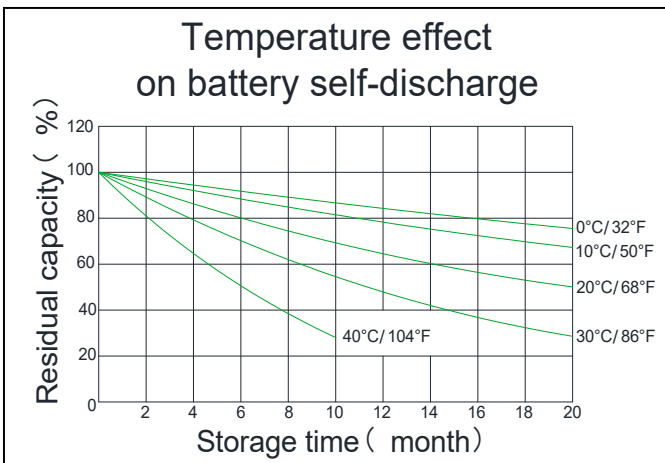
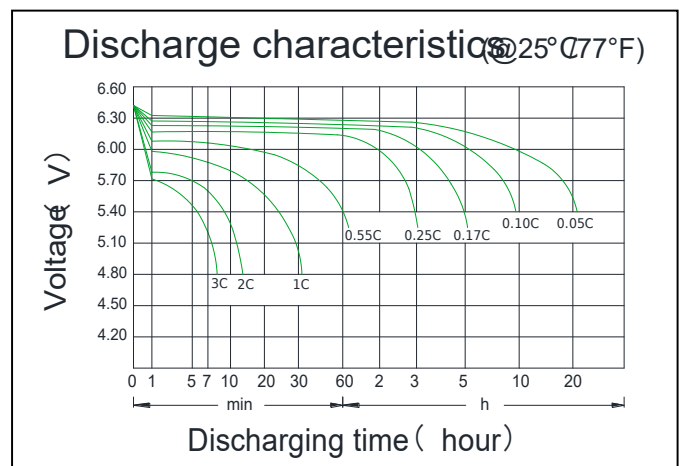
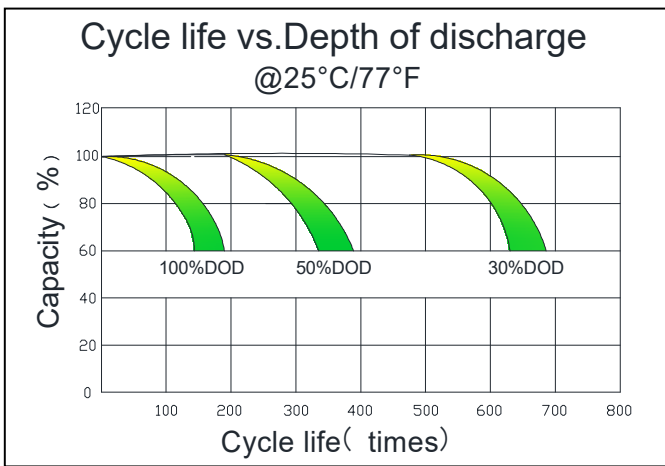
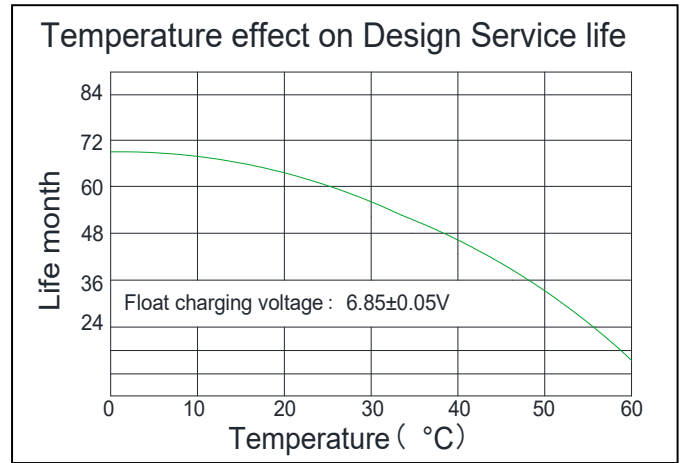
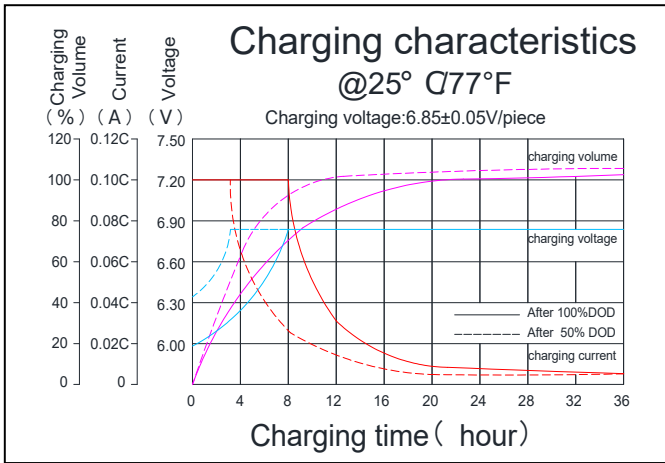

BATTERY CONSTRUCTION

Component	Positive plate	Negative plate	Container & Cover	Safety valve	Terminal	Separator	Electrolyte	Pillar seal
Features	Thick high Sn low Ca grid with special paste	Balanced Pb-Ca grid for improved recombination efficiency	ABS (UL94-V0 optional)	Flame Si-Rubbeand aging resistancer	Female Copper Insert (F1/F2)	Advanced AGM separator for high pressure cell design	Dilute high purity sulphuric acid	Two layers epoxy resin seal